

PRODUCT NUMBER

00372602

CATALOG NUMBER

**3725Z1PT
3726CPT DI**

**SPOKANE
B-25 MANHOLE
TYPE 2 UNIT**

LOAD RATING

HEAVY DUTY

COATING

DIPPED

ESTIMATED WEIGHT

COVER: 115 LBS
FRAME: 140 LBS
UNIT: 255 LBS

MATERIAL SPECIFICATION

COVER - DUCTILE IRON
ASTM A536
FRAME - GRAY IRON
ASTM A48 CL35B

OPEN AREA

N/A

✓ DESIGNATES MACHINED SURFACE

DRAWN
DEW

DATE
05/18/06

LAST REVISED
KH

DATE
10/08/07

REFERENCE INFORMATION

**00372518
00372622**

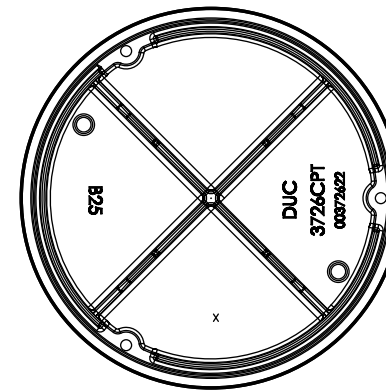
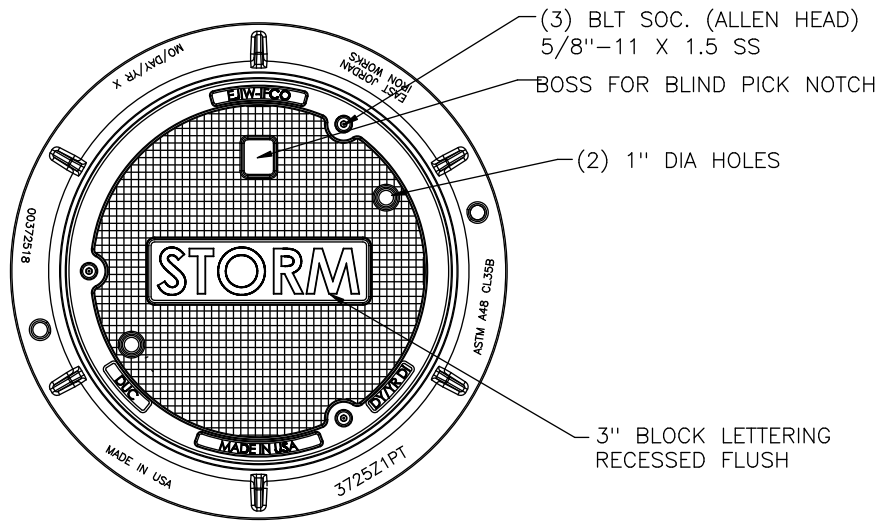

COVER BACK

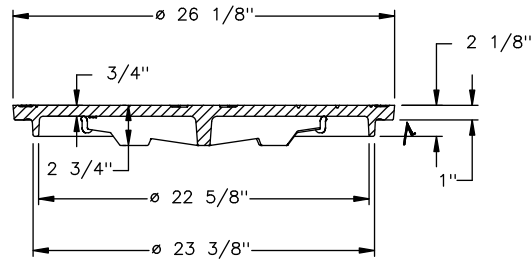

COVER SECTION

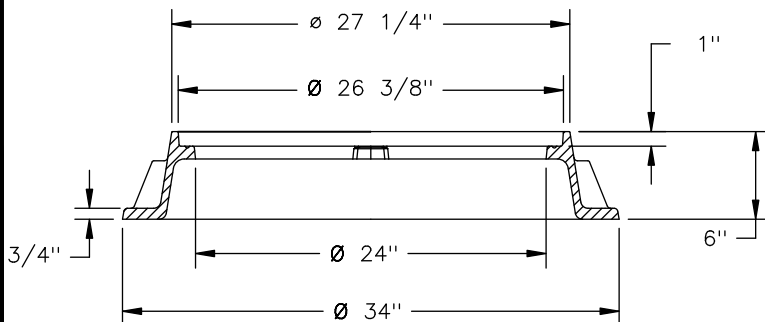

FRAME SECTION

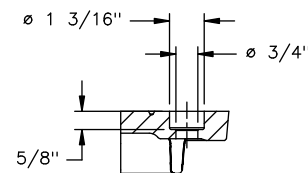

BOLTHOLE DETAIL