

PRODUCT NUMBER

00184856

CATALOG NUMBER

1848C

MANHOLE COVER

LOAD RATING

HEAVY DUTY

COATING

DIPPED

ESTIMATED WEIGHT

COVER: 140 LBS 64kg

MATERIAL SPECIFICATION

COVER - GRAY IRON
ASTM A48 CL35B

OPEN AREA

N/A

✓ DESIGNATES MACHINE SURFACE

DRAWN
DEW

DATE
06/09/06

LAST REVISED

DATE

REFERENCE INFORMATION

00184822

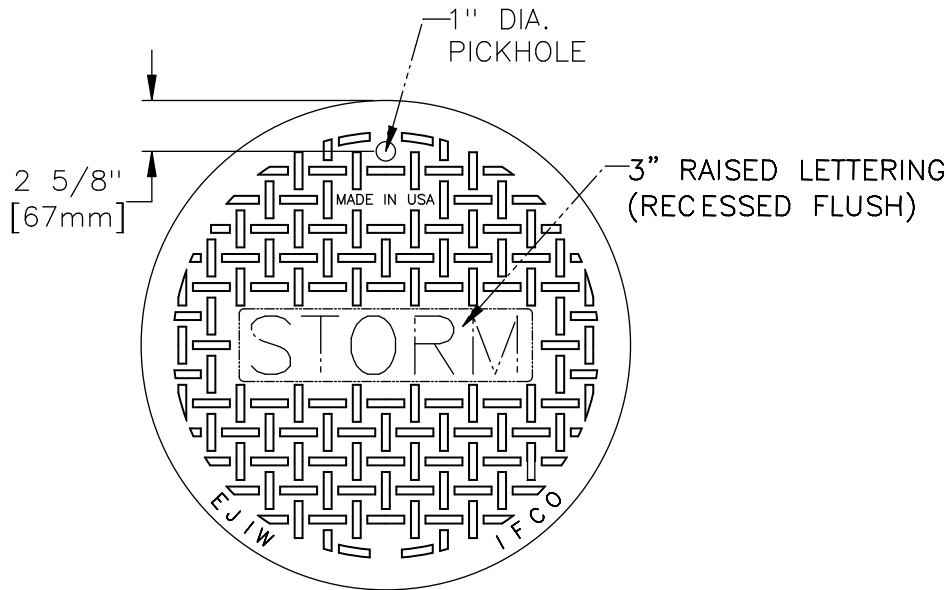

PLAN VIEW



BOTTOM VIEW

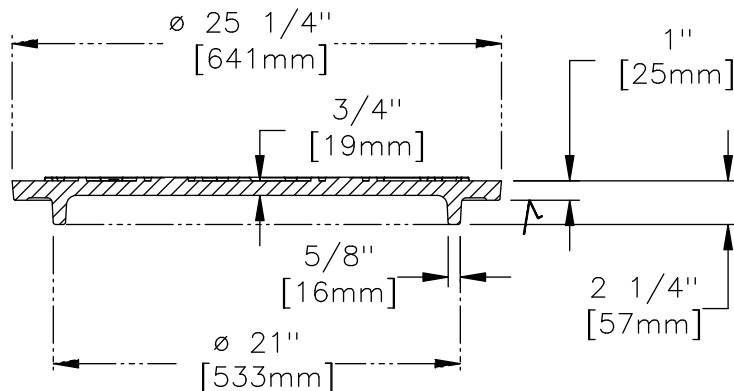

SECTION VIEW